

100 kN
GSZ-100-R | rotating screw

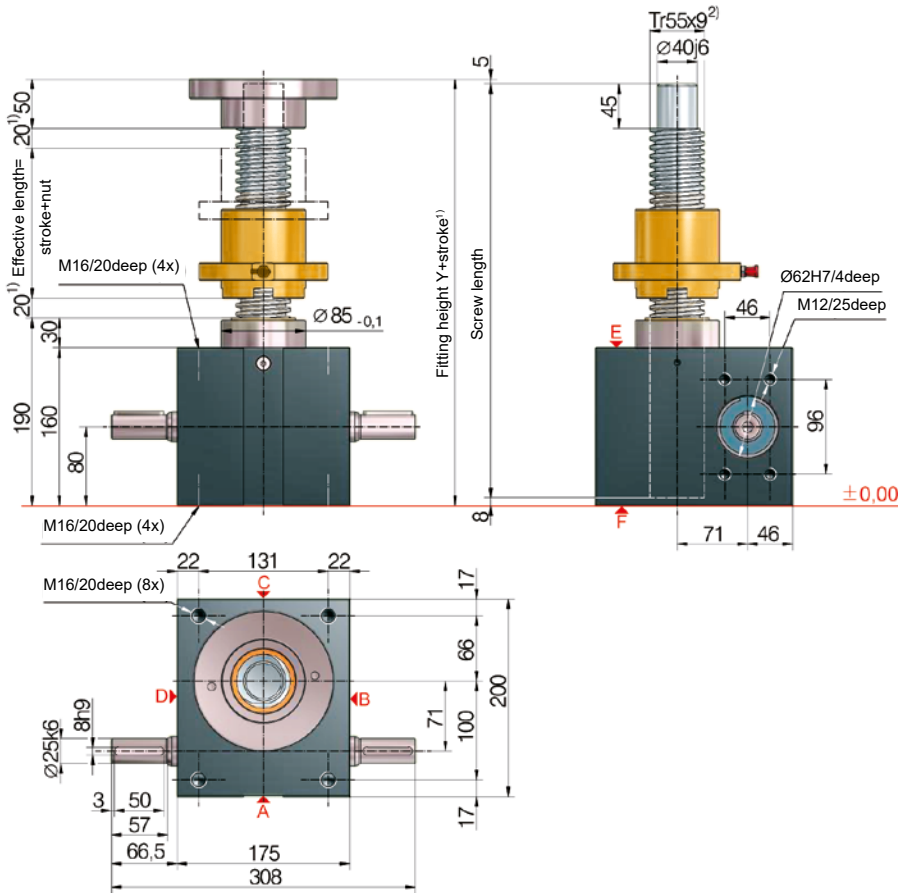

Standard configuration

Code	Gearbox (series)	Size	Version (variant)	Ratio	Screw	Stroke per drive shaft rotation
GSZ-100-RN	GSZ	100	R (rotating screw)	N (normal) 9:1	Tr 55x9	1,00 mm
GSZ-100-RL				L (low) 36:1		0,25 mm

100 kN

Duty cycle thermal limit

Ratio „N“ (9:1)

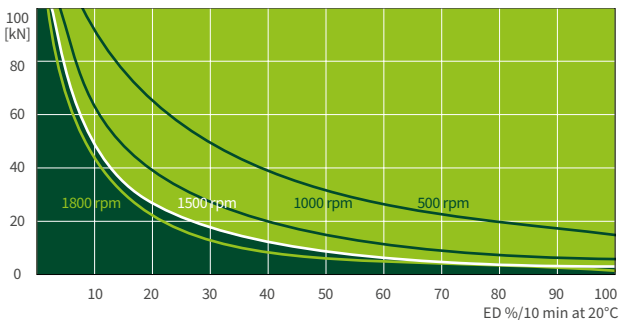

Ratio „L“ (36:1)

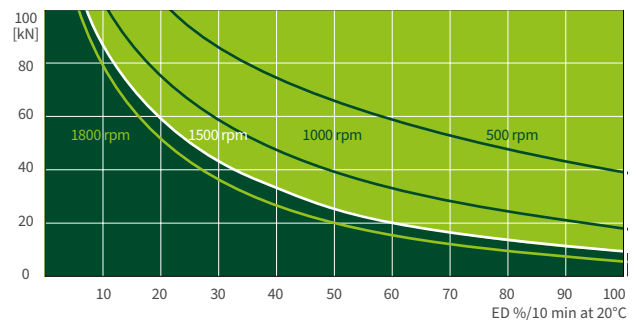

These curves are for guidance under standard industrial conditions (ambient temperature 20°C etc.) and correct maintenance (lubrication etc.). They are based on the ZIMM standard trapezoidal thread Tr 55x9. The operation cycles can be many times longer, when using ball screws.